



Antaira Technologies

LMX-2004G-SFP Series

20-Port Industrial Gigabit Managed Ethernet Switch, w/16*10/100/1000Tx and 4*100/1000 SFP Slots; 12~48VDC Power Input

Quick Installation Guide

Version 1.0
(November 2020)



Tel: 1-844-268-2472
Fax: 1-714-671-9944
www.antaira.com

Package Check List

The package contains the following items:

- 1 – Quick installation guide
- 1 – LMX-2004G-SFP(-T)
- 1 – Wall mounting bracket set with screws
- 1 – DC cable –18 AWG & DC jack 5.5 x 2.1mm
- 1 – RJ45 dust cover set
- 1 – RJ45 to DB9 serial console cable

Front Panel Layout

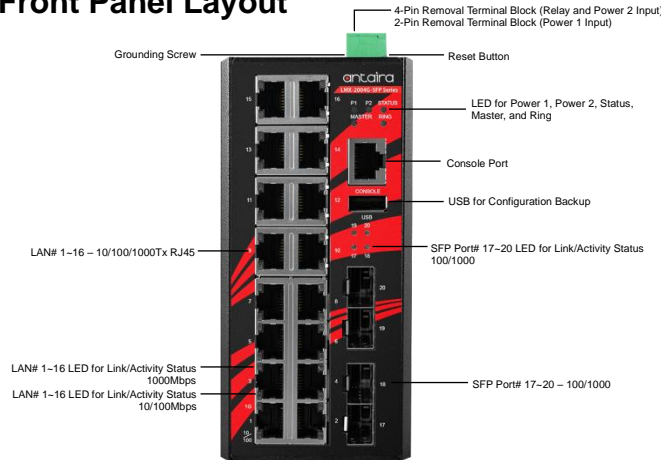

Top Panel View

LMX-2004G-SFP series top panel is equipped with a 4-pin removal terminal block connector (Relay and Power 2 Input) and a 2-pin removal terminal block connector (Power 1 Input) (12~48VDC).

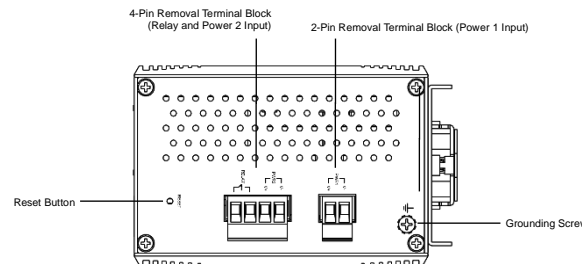

Product Overview

System Interface/Performance

- All RJ45 ports support the auto MDI function
- Embedded 16*10/100/1000Tx RJ45 ports and 4*100/1000 SFP slots
- Store-and-forward switching architecture
- 8K MAC address table
- Power line EFT protection: 2,000VDC; Ethernet ESD Protection: 6,000VDC

Power Input & Connection

- DC 12 to 48V redundant power, with a 4-Pin Removal Terminal Block (Relay and Power 2 Input) and a 2-Pin Removal Terminal Block (Power 1 Input)
- It is recommended to use a UL listed industrial power supply

Operating Temperature

- Standard operating temperature model: -10°C to 70°C
- Extended operating temperature model: -40°C to 75°C

Case/Installation

- IP30 protection
- DIN-Rail and wall mount design

LED Indicators

LED	Color	Description	
		State	Description
Power 1	Green	On	Power input 1 is active
		Off	Power input 1 is inactive
Power 2	Green	On	Power input 2 is active
		Off	Power input 2 is inactive
Status	Green	On	The system ready and work fine, and there are no events occur
	Red	On	System booting or an applied alarm (such as port disconnect) has been triggered
Master	Green	On	ERPS Owner Mode (Ring Master) is ready
		Off	ERPS Owner Mode is not active
Ring	Green	On	Ring Network is active
		Off	Ring Network is not active
LAN Port 1-16 (Upper LED)	Green	On	Connected to network, 1000Mbps
		Flashing	Networking is active
		Off	Not connected to network
LAN Port 1-16 (Lower LED)	Green	On	Connected to network, 10/100Mbps
		Flashing	Networking is active
		Off	Not connected to network
LINK/ACT (SFP Port 17-20)	Green	On	Connected to network, 1000Mbps
		Flashing	Networking is active
		Off	Not connected to network
	Amber	On	Connected to network, 100Mbps
		Flashing	Networking is active
		Off	Not connected to network

Quick Installation

Ethernet Ports

RJ45 Ports (Auto MDI)

All RJ45 ports are auto-sensing for 10Base-T, 100Base-TX or 1000Base-T device connections. Please follow the wiring pin assignment table below for Ethernet port installation.

Warranty Policy

Warranty Conditions

Products supplied by Antaira Technologies are covered in this warranty for sub-standard performance or defective workmanship. The warranty is not, however, extended to goods damaged in the following circumstances:

- Excessive forces or impacts
- War or an Act of God: wind storm, fire, flood, electric shock, earthquake
- Use of unqualified power supply, connectors, or unauthorized parts/kits
- Replacement with unauthorized parts

RMA and Shipping Costs Reimbursement

Customers shall always obtain an authorized "RMA" number from Antaira before shipping the goods for repair or replacement.

- Within the warranty period (based on the invoice date), all parts and labor are free of charge to the customers.
- Customers are responsible for the cost of parts and labor, if the products are out of warranty.
- For RMA service, customers are responsible for the shipping expense for shipping the RMA unit(s) to Antaira. Antaira is responsible for the shipping expense via a ground service for the return repair/replace unit(s) back to customers.

Limited Liability

Antaira would not be held responsible for any consequential losses from using Antaira's product.

Warranty Period

5-Year Warranty

Antaira's Customer Service and Support

- Antaira's Technical Service & Support Centers:
 - + 844-268-2472 (Antaira US Headquarter)
 - + 48-22-862-88-81 (Antaira Europe Office)
 - + 886-2-2218-9733 (Antaira Asia Office)

- Antaira's Web Sites & Repair/Support Emails:
 - www.antaira.com / support@antaira.com
 - www.antaira.eu / info@antaira.eu
 - www.antaira.com.tw / info@antaira.com.tw

*Any changes will be announced on the Antaira website.

RJ45 Ethernet Port Pin Outs				
Pins	T568A Color	T568B Color	10Base-T, 100Base-TX	1000 Base-T(X)
Pin 1	white/green stripe	white/orange stripe	Rx+	TP0+
Pin 2	green solid	orange solid	Rx-	TP0-
Pin 3	white/orange stripe	white/green stripe	Tx+	TP1+
Pin 4	blue solid	blue solid	unused	TP2+
Pin 5	white/blue stripe	white/blue stripe	unused	TP2-
Pin 6	orange solid	green solid	Tx-	TP1-
Pin 7	white/brown stripe	white/brown stripe	unused	TP3+
Pin 8	brown solid	brown solid	unused	TP3-

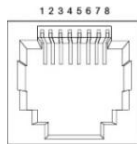

Figure 4

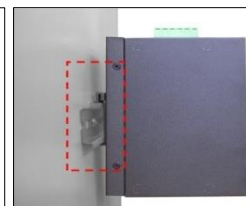

Figure 5

Wall Mounting

Follow the steps below to mount the industrial Ethernet switch using the wall mounting bracket as shown below in Figure 6.

- Remove the DIN-Rail bracket from the industrial Ethernet switch by loosening the screws.
- Place the wall mounting brackets on the top and bottom of the industrial Ethernet switch.
- Use the screws to screw the wall mounting bracket onto the industrial Ethernet switch.
- Use the hook holes at the corners of the wall mounting bracket to hang the industrial Ethernet switch on the wall.
- To remove the wall mount bracket, do the opposite from the steps above.

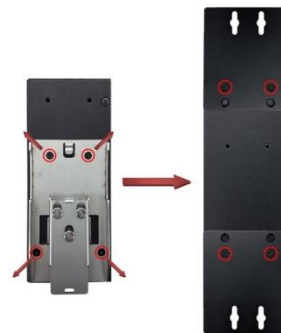

Figure 6

Power Input Wiring

Please follow the steps below to insert the power wire:

- Insert the positive and negative wires into the **PWR1 (V1+, V1-)** and **PWR2 (V2+, V2-)** contacts on the terminal block connector as shown below in Figure 1.
- Tighten the wire-clamp screws to prevent the wires from loosening, as shown below in Figure 2.

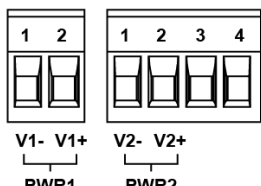

Figure 1

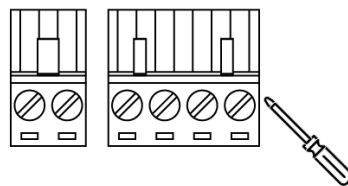

Figure 2

Industrial Switch Mounting

DIN-Rail Mounting

The DIN-Rail bracket is pre-installed on the industrial Ethernet switch from the factory. Please refer to Figure 3 for a DIN-Rail bracket installation reference.

Follow the steps below for installing the industrial switch on the DIN-Rail track:

- Insert the top of the DIN-Rail onto the track as shown in Figure 4.
- Lightly pull down the bracket onto the rail as shown in Figure 5.
- Check if the bracket is mounted tightly on the rail.
- To remove the industrial Ethernet switch from the rail, do the opposite from the steps above.

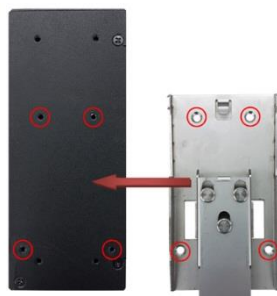

Figure 3

Field Maintenance and Service

- If the device requires servicing of any kind, the user is required to disconnect and remove it from its mounting. The initial installation should be done in a way that makes this as convenient as possible.
- Voltage/power lines should be properly insulated as well as other cables. Be careful when handling them so as to not trip over.
- Do not under any circumstance insert foreign objects of any kind into the heat dissipation holes located in the different faces of the device. This may not only harm the internal layout, but might cause harm to user as well.
- Do not under any circumstance open the device for any reason. Please contact your dealer for any repair needed or follow the instructions within the manual.